



## CoreGaN 650V GaN HEMT

### Description

The CE65H160TOAIF Series 650V, 160mΩ gallium nitride (GaN) FETs are normally-off devices.

Coreenergy GaN FETs offer better efficiency through lower gate charge, faster switching speeds, and lower dynamic on-resistance, delivering significant advantages over traditional silicon (Si) devices.

Coreenergy is a leading-edge wide band gap supplier with world-class innovation .

### Application

- Adapter
- Renewable energy
- Telecom and data-com
- Servo motors
- Industrial
- Automotive

### General Features

Easy to drive—compatible with standard gate drivers  
 Low conduction and switching losses  
 RoHS compliant and Halogen-free

### Benefits

Increased efficiency through fast switching  
 Increased power density  
 Reduced system size and weight

### Ordering Information

Part Number	Package	Package Configuration
CE65H160TOAIF	TO220F	Source

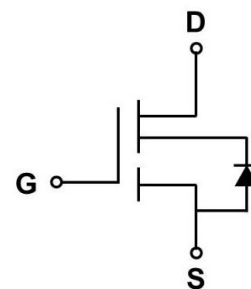
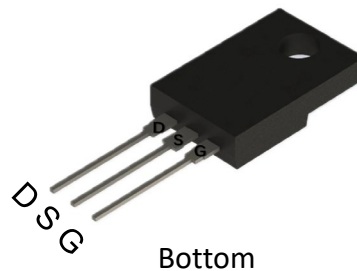
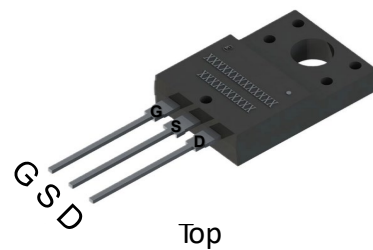

Circuit Symbol

### Features

$BV_{DSS}$	$R_{DS(on)}$	$I_{DS}$	$Q_G$
650V	160mΩ	10A	7.4nC



## Absolute Maximum Ratings

$T_c=25^\circ\text{C}$  unless otherwise stated

Symbol	Parameter	Limit value	Unit	
$V_{DSS}$	Drain to source voltage ( $T_J = -55^\circ\text{C}$ to $150^\circ\text{C}$ )	650		
$V_{(TR)DSS}$	Drain to source voltage-transient <sup>a</sup>	800	V	
$V_{GSS}$	Gate to source voltage	-20~+20		
$I_D$	Continuous drain current @ $T_c=25^\circ\text{C}$ <sup>b</sup>	10	A	
	Continuous drain current @ $T_c=125^\circ\text{C}$ <sup>b</sup>	4.5	A	
$I_{DM}$	Pulse drain current (pulse width: 10 $\mu\text{s}$ )	27	A	
$P_D$	Maximum power dissipation @ $T_c=25^\circ\text{C}$	42	W	
$T_c$	Operating temperature	Case	-55~150	$^\circ\text{C}$
$T_J$		Junction	-55~150	$^\circ\text{C}$
$T_S$	Storage temperature	-55~150	$^\circ\text{C}$	

a. In off-state, spike duty cycle  $D < 0.01$ , spike duration  $< 1\mu\text{s}$

b. For increased stability at high current operation



## Thermal Resistance

Symbol	Parameter	Limit value	Unit
$R_{\theta JC}$	Junction-to-case	2.95	°C /W



## Electrical Parameters

$T_J=25^\circ\text{C}$  unless otherwise stated

Symbol	Parameter	Min	Typ	Max	Unit	Test Conditions
<b>Forward Device Characteristics</b>						
$V_{(BL)DSS}$	Drain-source voltage	650	-	-	V	$V_{GS}=0V$
$V_{GS(th)}$	Gate threshold voltage	3.3	3.9	4.5	V	$V_{DS}=1V, I_{DS}=1mA$
$\Delta V_{GS(th)}/T_J$	Gate threshold voltage temperature coefficient	-	-7	-	mV/ $^\circ\text{C}$	
$R_{DS(on)}$	Drain-source on-Resistance	-	160	210	m $\Omega$	$V_{GS}=10V, I_D=1A, T_J=25^\circ\text{C}$
		-	340	-		$V_{GS}=10V, I_D=1A, T_J=150^\circ\text{C}$
$I_{DSS}$	Drain-to-source leakage current	-	1	10	$\mu\text{A}$	$V_{DS}=650V, V_{GS}=0V, T_J=25^\circ\text{C}$
		-	5	100		$V_{DS}=650V, V_{GS}=0V, T_J=150^\circ\text{C}$
$I_{GSS}$	Gate-to-source forward leakage current	-	-	$\pm 100$	nA	$V_{GS}=\pm 20V$
$C_{ISS}$	Input capacitance	-	330	-	pF	$V_{GS}=0V, V_{DS}=400V, f=1\text{MHz}$
$C_{OSS}$	Output capacitance	-	25	-		
$C_{RSS}$	Reverse capacitance	-	1	-		
$Q_G$	Total gate charge	-	7.4	-	nC	$V_{DS}=400V, V_{GS}=0V \text{ to } 10V, I_D=1A$
$Q_{GS}$	Gate-source charge	-	2.6	-		
$Q_{GD}$	Gate-drain charge	-	1.8	-		
$Q_{OSS}$	Output charge	-	34	-	nC	$V_{GS}=0V, V_{DS}=0V \text{ to } 400V, f=1\text{MHz}$
$t_{D(on)}$	Turn-on delay	-	3.2	-	ns	$V_{DS}=400V, V_{GS}=0V \text{ to } 10V, I_D=2.1A,$ $R_{G-on(ext)}=6.8\Omega, R_{G-off(ext)}=2.2\Omega,$ $L=250\mu\text{H}$
$t_R$	Rise time	-	5.5	-		
$t_{D(off)}$	Turn-off delay	-	7.4	-		
$t_F$	Fall time	-	27	-		



## Electrical Parameters

$T_j=25^\circ\text{C}$  unless otherwise stated

Symbol	Parameter	Min	Typ	Max	Unit	Test Conditions
<b>Reverse Device Characteristics</b>						
$V_{SD}$	Source-Drain reverse voltage	-	2.5	-	V	$V_{GS}=0\text{V}$ , $I_{SD}=10\text{A}$
$t_{RR}$	Reverse recovery time	-	14	-	ns	$I_F=10\text{A}$ , $V_{DD}=400\text{V}$ , $di_F/dt=165\text{A}/\mu\text{s}$
$Q_{RR}$	Reverse recovery charge	-	6.5	-	nC	



### Typical Characteristics

$T_j=25^\circ\text{C}$  unless otherwise stated

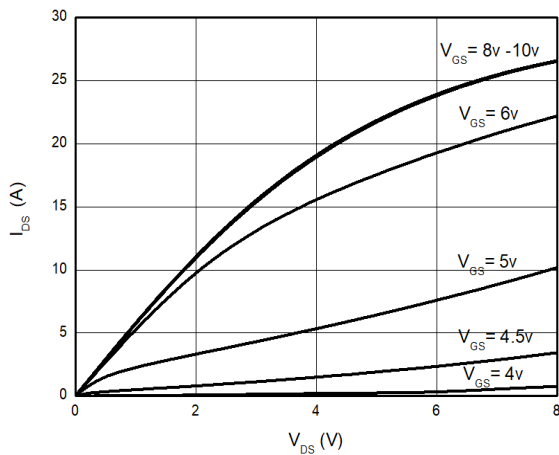

Figure 1. Typical Output Characteristics  $T_j=25^\circ\text{C}$

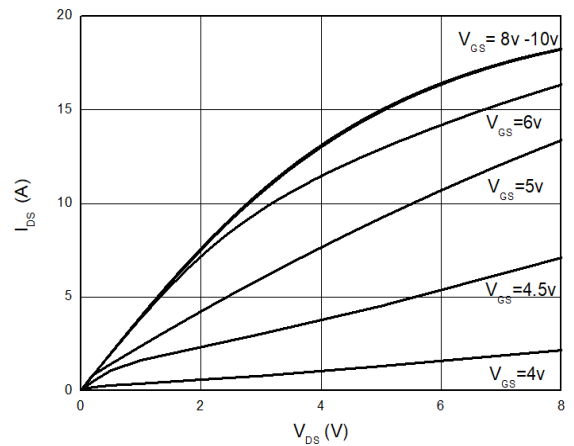

Figure 2. Typical Output Characteristics  $T_j=125^\circ\text{C}$

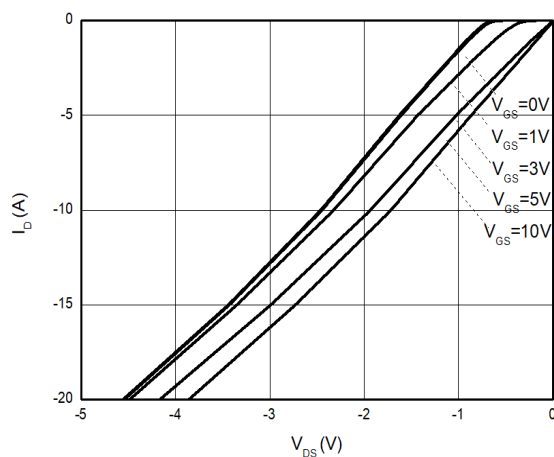

Figure 3. Channel Reverse Characteristics  $T_j=25^\circ\text{C}$

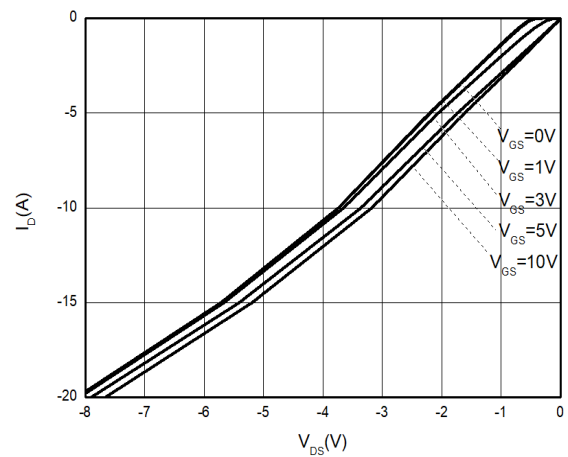

Figure 4. Channel Reverse Characteristics  $T_j=125^\circ\text{C}$



### Typical Characteristics

$T_j=25^\circ\text{C}$  unless otherwise stated

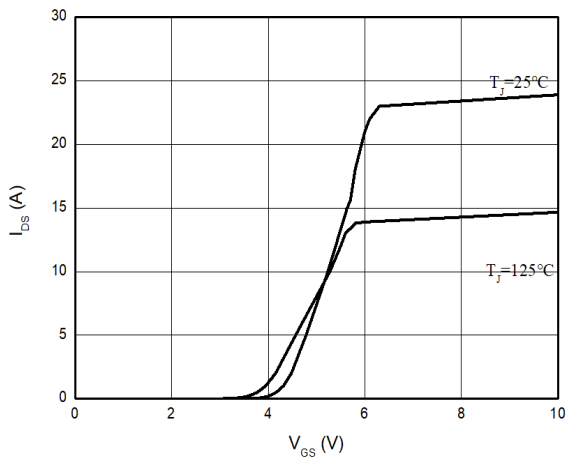

Figure 5. Typical Transfer Characteristics ( $V_{DS}=10\text{V}$ )

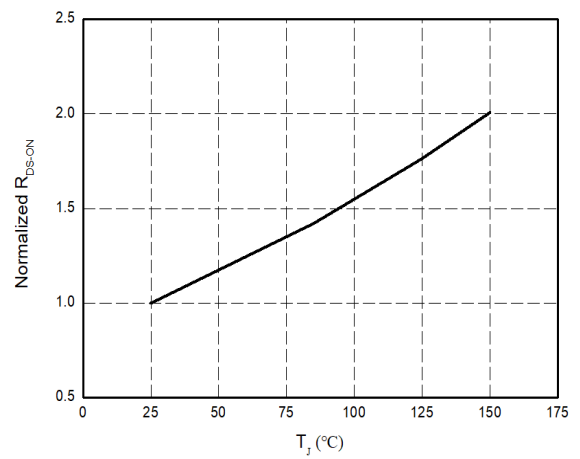

Figure 6. Normalized On-resistance

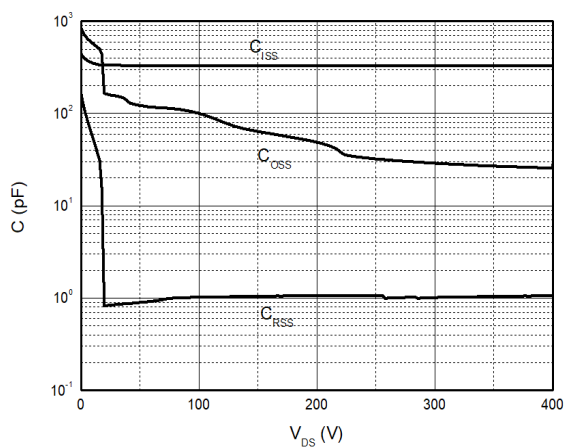

Figure 7. Typical Capacitance ( $f=1\text{MHz}$ )

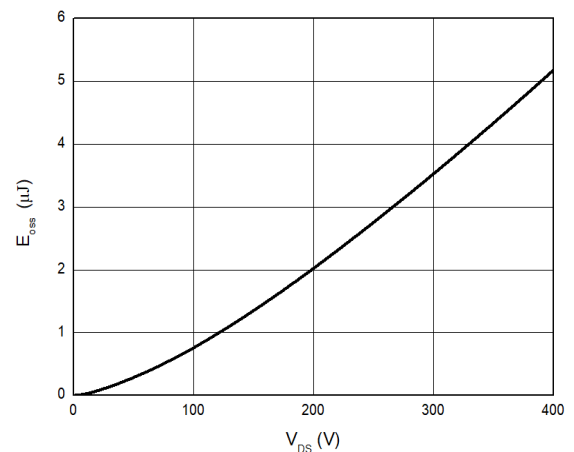

Figure 8. Typical  $C_{oss}$  Stored Energy



### Typical Characteristics

$T_j=25^\circ\text{C}$  unless otherwise stated

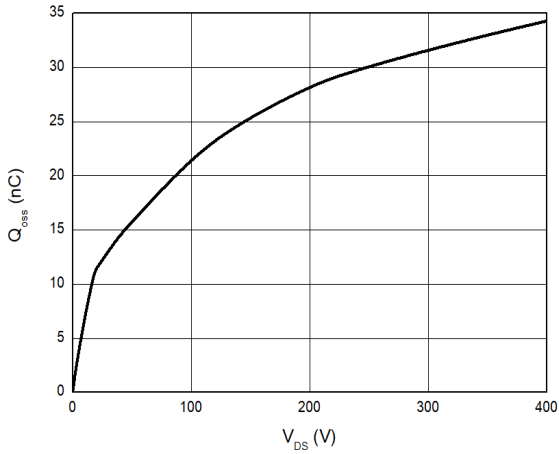

Figure 9. Typical  $Q_{oss}$

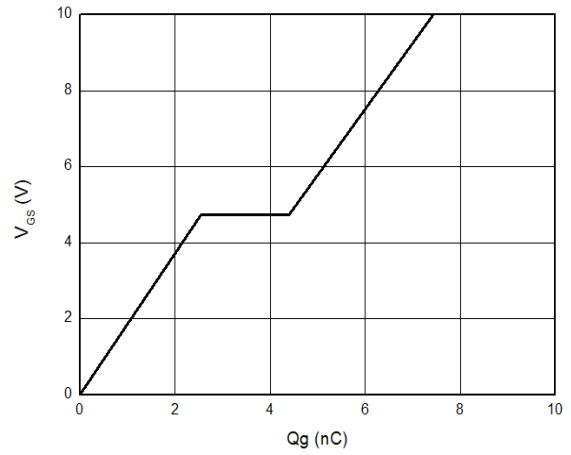

Figure 10. Typical Gate Charge ( $V_{DS}=400\text{V}$ ,  $I_D=1\text{A}$ )

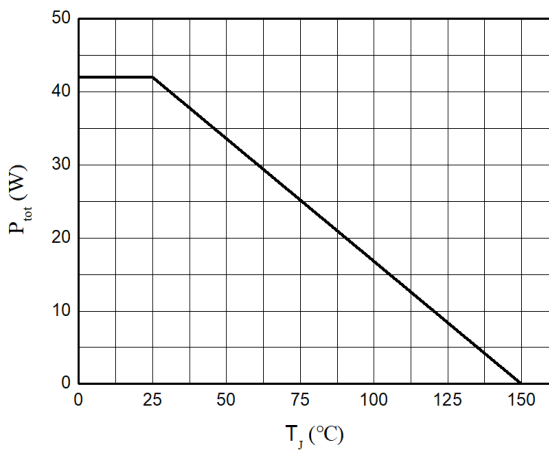

Figure 11. Power Dissipation

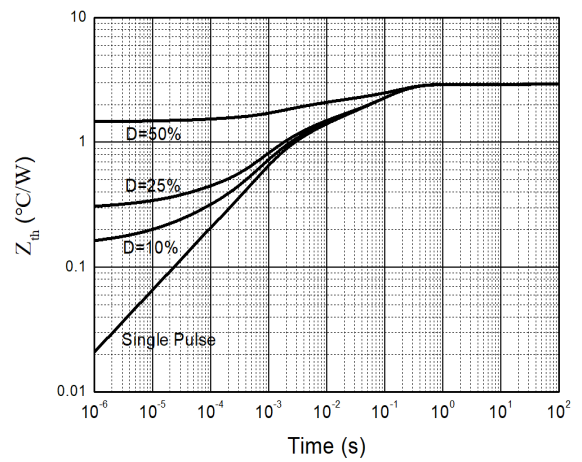

Figure 12. Transient Thermal Resistance



### Typical Characteristics

$T_j=25^\circ\text{C}$  unless otherwise stated

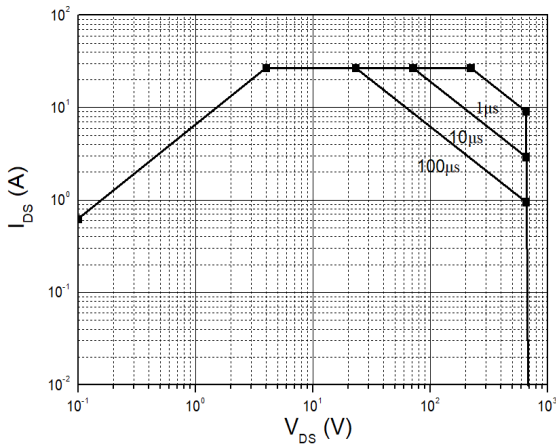

Figure 13. Safe Operating Area  $T_c=25^\circ\text{C}$

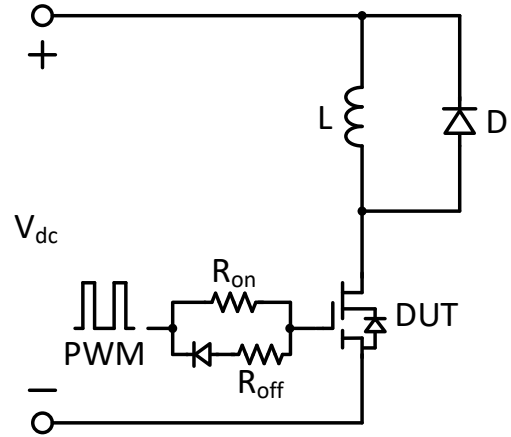

Figure 14. Switching times with inductive load

$V_{DS}=400\text{V}$ ,  $V_{GS}=0\text{V to }10\text{V}$ ,  $I_D=2.1\text{A}$ ,  
 $R_{G-on(ext)}=6.8\Omega$ ,  $R_{G-off(ext)}=2.2\Omega$ ,  $L=250\mu\text{H}$

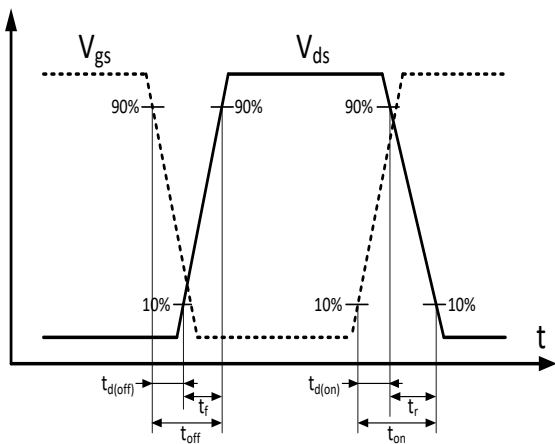
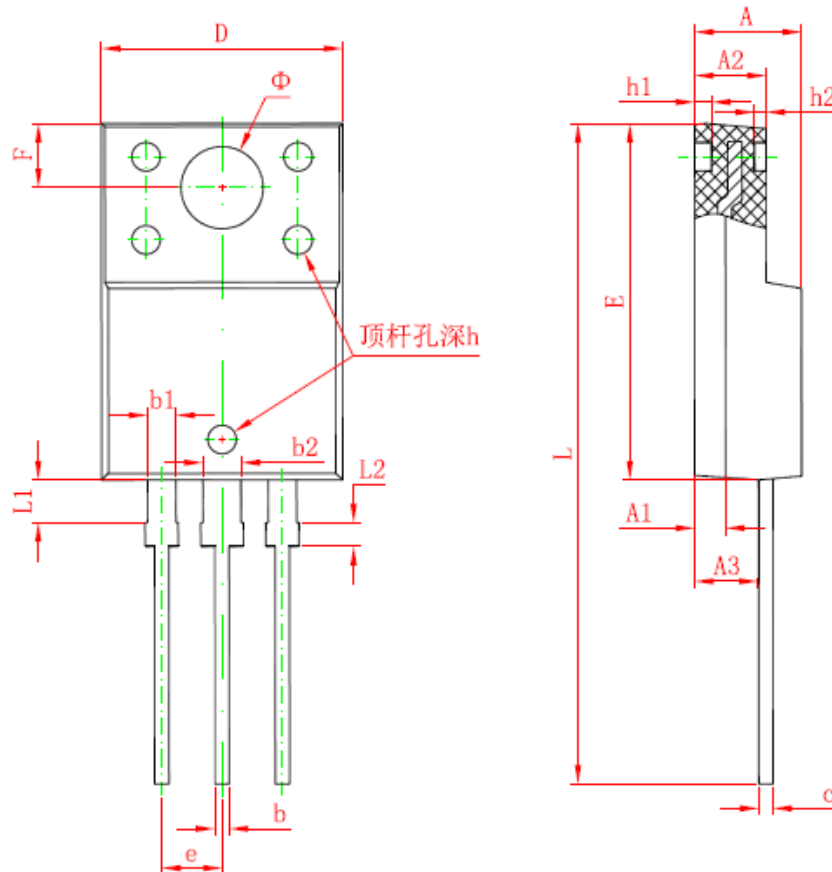

Figure 15. Switching times with waveform

## PACKAGE DIMENSIONS

TO220F-3L



Symbol	Dimensions In Millimeters		Dimensions In Inches	
	Min.	Max.	Min.	Max.
A	4.300	4.700	0.169	0.185
A1	1.300 REF.		0.051 REF.	
A2	2.800	3.200	0.110	0.126
A3	2.500	2.900	0.098	0.114
b	0.500	0.750	0.020	0.030
b1	1.100	1.350	0.043	0.053
b2	1.500	1.750	0.059	0.069
c	0.500	0.750	0.020	0.030
D	9.960	10.360	0.392	0.408
E	14.800	15.200	0.583	0.598
e	2.540 TYP.		0.100 TYP.	
F	2.700 REF.		0.106 REF.	
$\Phi$	3.500 REF.		0.138 REF.	
h	0.000	0.300	0.000	0.012
h1	0.800 REF.		0.031 REF.	
h2	0.500 REF.		0.020 REF.	
L	28.000	28.400	1.102	1.118
L1	1.700	1.900	0.067	0.075
L2	0.900	1.100	0.035	0.043



## Revision history

### Major changes since the last revision

Revision	Date	Description of changes
1.0	2022-02-28	Initial release
2.0	2023-10-30	Enrich dynamic specification curves
3.0	2023-12-25	Update dynamic parameters